

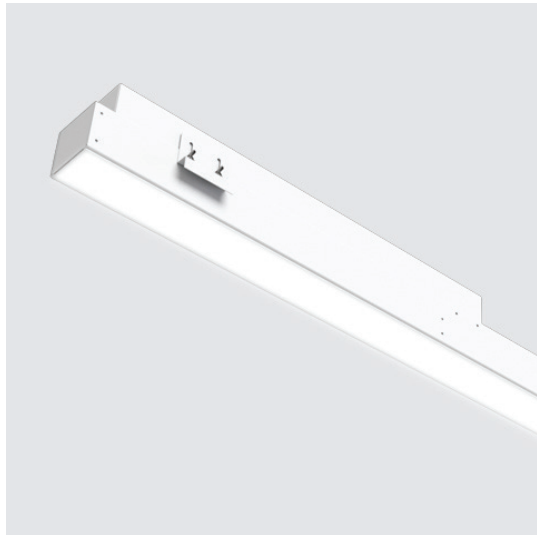

DLC on Some Linear Models

Date: _____ Fixture: _____
 QTY: _____ Project: _____



Thinline 4.5

Recessed T-Grid
Multiple Lens and Customizations Available

Architectural luminaire. Recessed mounting. Slim contemporary design. Continuous runs with lit corners available. L90 > 70K Hours. Designed and manufactured in North America. 10 Year Warranty.

Performance

Color Temp	Lm/W
4000K	120 Lm/W
3500K	116 Lm/W
3000K	112 Lm/W

Ordering Options

MODEL	LENGTH	DIR LUMENS	COLOR TEMP	VOLTAGE	LENS	FINISH
DTL TG 4.5	CR _____ Min 2' Available in 6" Increments	D 250 D 500 D 750 D 1000 D _____ Custom Up to 1200	27K 2700K 3K 3000K 35K 3500K 4K 4000K 5K 5000K	U 120/277V H 347V	FR Frosted FRREG Frosted Regressed ASY Asymmetric .5" FR DROP 2" FR DROP	WH White CU Custom

DTL TG 4.5

DRIVER	CONTROLS	ACCESSORIES	WIRING	WIRE LENGTH
DIMOFF 0-10 1% DIMOFF Driver LUTRON Lutron Ecosystem Driver SR Philips SR DALI ELDO .1% ELDO LED Driver * 347 only in 1 - 10 5%	N None DMX SNS Philips SNS 300 w/ BLD & Daylight CLM Encelium CLM LG LG Dongle BT Bluetooth Mesh EN Enlighted Integral	N None 10kV 10kV Surge Protection 6W 90 Min BAT	5 WIRE 6 WIRE +GTD Generator Transfer Device N None	_____'

DOWNLIGHT
DL# _____ POS _____ POS END MID BEG MULTIPLE

SAMPLE: DTL TG 4.5 - CR8 - 500 - 35K - U - FR - WH - DIMOFF - N - N - 5WIRE - 6' - DLO

Specifications subject to change without notice.

Note: Not all products are qualified on the DLC QPL. To view our DLC qualified products, please consult the DLC qualified products list at www.designlights.org/qpl.

LED

L90 > 70,000

Samsung 301 3 McAdam Binning

4000K 120 Lm/W

3500K 98%

3000K 96%

90 CRI 85%

Optics

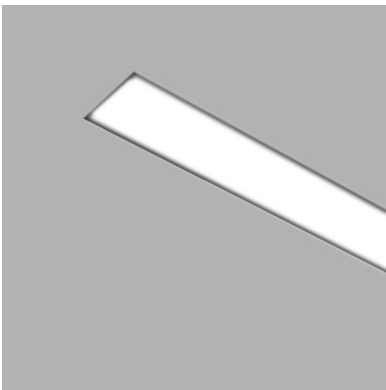

Flat

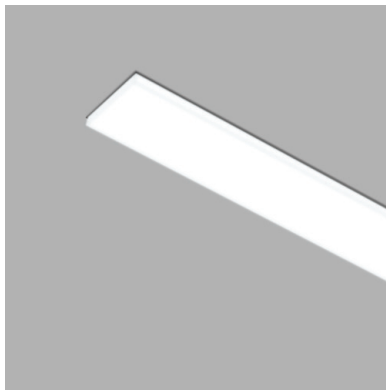

0.5" Step Lens

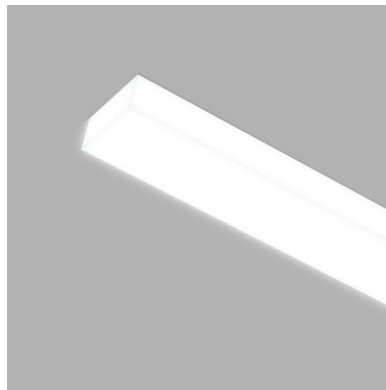

2" Step Lens

Downlight

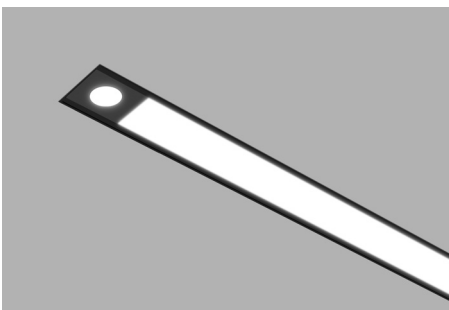

Start

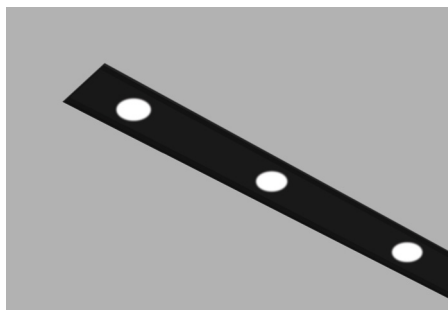

Multiple

Beam 60°

Lumens 50

Watts 4

Lens Options

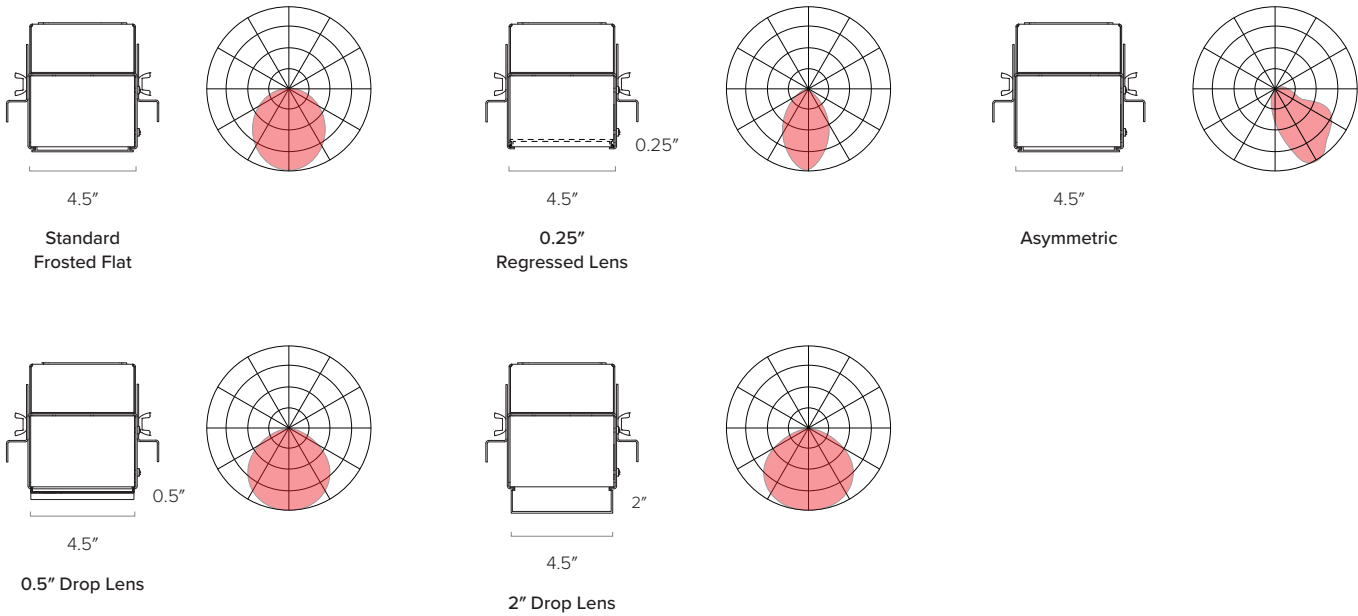

Measurements

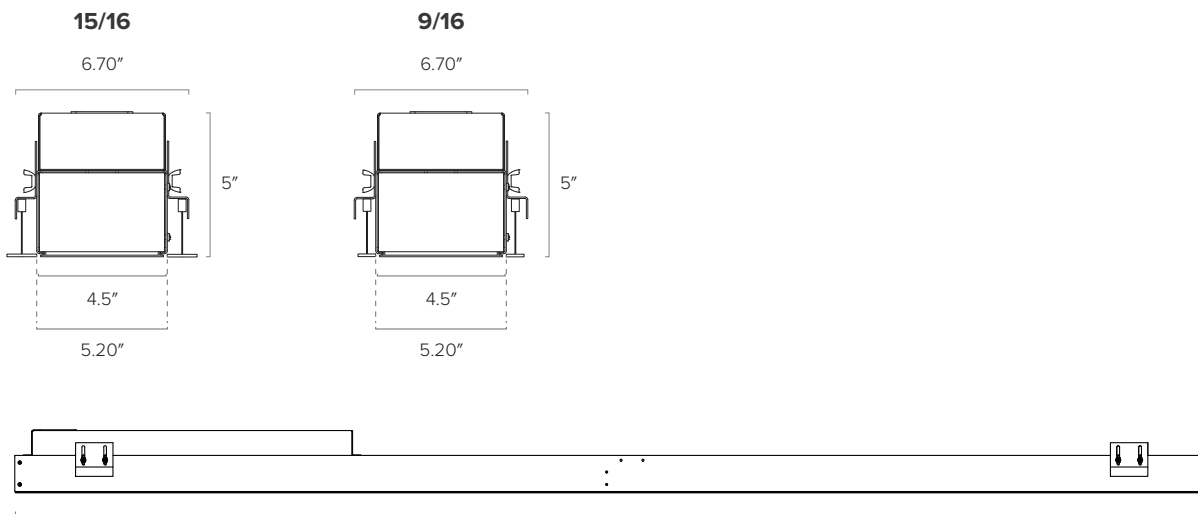

Note: Dimensions are for reference only. Please make measurements for actual dimensions

Lit Corner Hubs

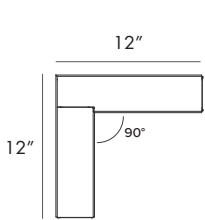
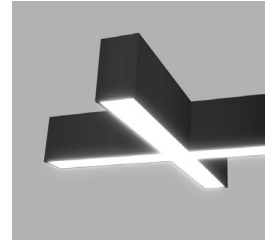
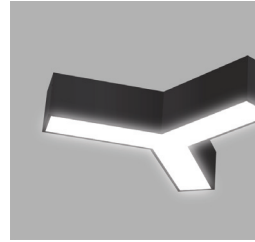
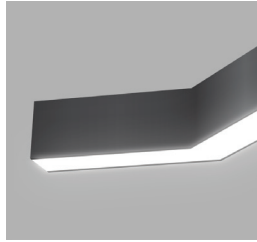
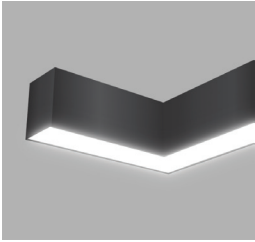

Lit Corner 90°

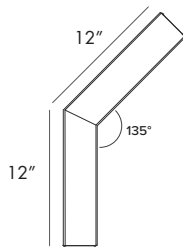

Lit Corner 135°

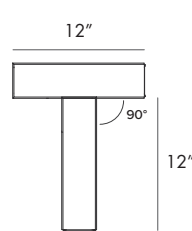

T-Hub

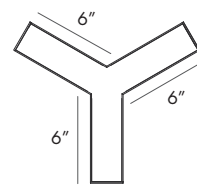

Y-Hub

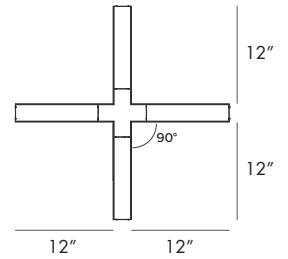

X-Hub

**** Custom Available ****

Lit Corner Hubs - Shapes

Sample Configurations

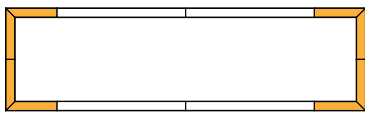

Lit Corner Hub 90°

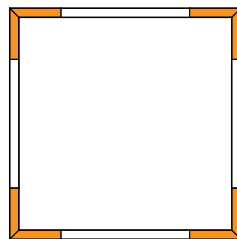

Lit Corner Hub 90°

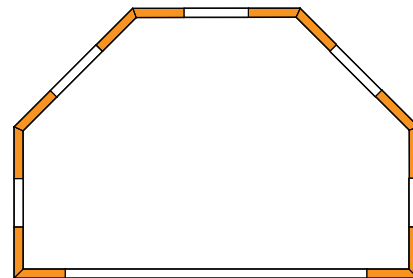

Lit Corner Hub 90° & Lit Corner Hub 135°

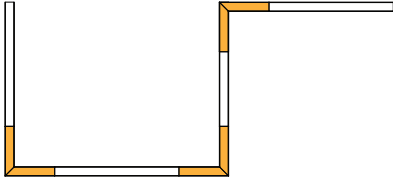

Lit Corner Hub 90°



Lit Corner Hub 90°

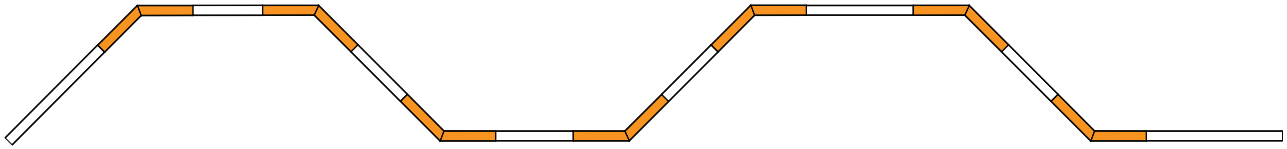

Lit Corner Hub 135°

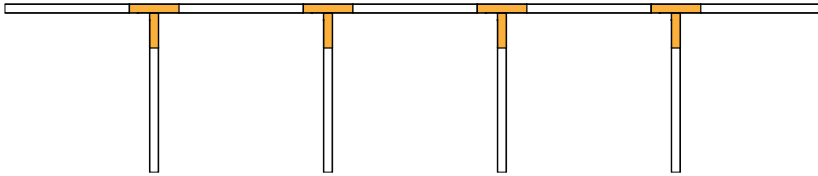

Lit Corner T-Hub

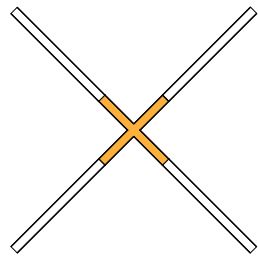

Lit Corner X-Hub

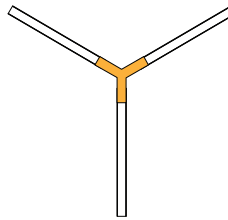

Lit Corner Y-Hub